

- **1 Ethernet Modbus TCP link for 12 modules (optional Wifi or GSM network)**

Internal bus for communication between modules

- **Input / Output communicating module**

Up to 24 isolated inputs/outputs by module

- **temperature inputs module**

RTD (PT100, PT1000)

Thermistor CTN , CTP

Thermocouple (B,E,J,K,R,S,T,...)

- **Process input module**

0..1....5....10Volts ; 0..4.....20mA ;

- **Digital input Module**

Read state, counting, time measurement

- **Relays output module**

Command, alarm, ...

- **Analog outputs module**

0..4..20mA, 0....10V, +/-10V, +/-20mA

- **Wattmeter, energy meter module**

Measure : voltage, current, power, phase, energy,

- **Application :**

- remote measuring and command interface for calculator, PLC, PC ...

- Monitoring, supervision, management

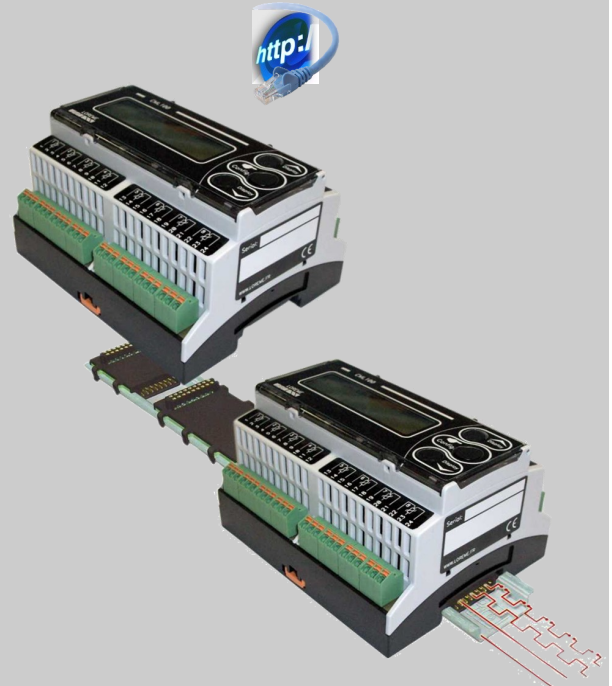

The Bus100 modular system provide an interconnection on Ethernet network, of different input / output and analogical acquiring module. The internal Bus (snap-on mounting on DIN rail) allow the connection of 12 modules. A "stand-alone" mode allows to an acquiring master module to drive directly an output relays module (local alarm).

Functional description:

The Bus100 system is made up of a head-end module (with Ethernet socket) and slave modules ("BUS" module without Ethernet).

All modules are reachable through the Ethernet link. The Bus100 have two type of configuration:

1) simple mode (homogeneous): All modules are the same type. In this case the head-end is implemented in the first module, thus simplify the Bus structure and reduce cost.

2) extended mode (heterogeneous): Modules can be different. In this case the network head-end is a separate module (Ethernet, Wifi, GSM), all modules are slaves ("Bus" type), the head-end ensuring the gateway and the control of the Bus.

Module description: different type of module are available (Report to individual datasheet for more details):

CML100: Module with 8/16 not isolated analogical inputs (mA, A, Volt, temperature)

CML165: Module with 12 isolated analogical inputs (mA, A, Volt, temperature,..)

ELL100: Module with 16 digitals inputs (dry contact, NPN, PNP, voltage)

ELL165: Module with 24 digitals inputs (dry contact, NPN, PNP, voltage)

SRL100: Module with 8 output relays (free potential changeover contact)

SRL165: Module with 12 output relays (free potential changeover contact)

SAL100: Module with 8 not isolated analog outputs (4..20mA, 0..10V)

SRAL165:Module with 8 isolated analog outputs (4..20mA, 0..10V, +/-20mA)

CPL105: Wattmeter, energy meter three-phase, single phase

CPL165: Multi branch circuits meter, wattmeter, energy meter

<http://www.loreme.fr/fichtech/CML100.pdf>

<http://www.loreme.fr/fichtech/CML165.pdf>

<http://www.loreme.fr/fichtech/ELL100.pdf>

<http://www.loreme.fr/fichtech/ELL165.pdf>

<http://www.loreme.fr/fichtech/SRL165.pdf>

<http://www.loreme.fr/fichtech/SRAL165.pdf>

<http://www.loreme.fr/fichtech/CPL105.pdf>

<http://www.loreme.fr/fichtech/CPL165.pdf>

Special function:

In option, an internal "stand-alone" mode is available: in this mode a "bus" module is directly controlled by the master module (no external command is needed)

Example: The master is an analogical acquiring module (CML100) associated with a "bus" module like an output relays module (SRL100).

This operating mode allows to control local temperature alarms in autonomous way. Only one master module and one slave module per bus are possible in this special mode. This system may be used in this case, in autonomous way without external communication (alarms unit).

Homogeneous bus : (modules on bus are the same type) The head-end is implemented in first module.

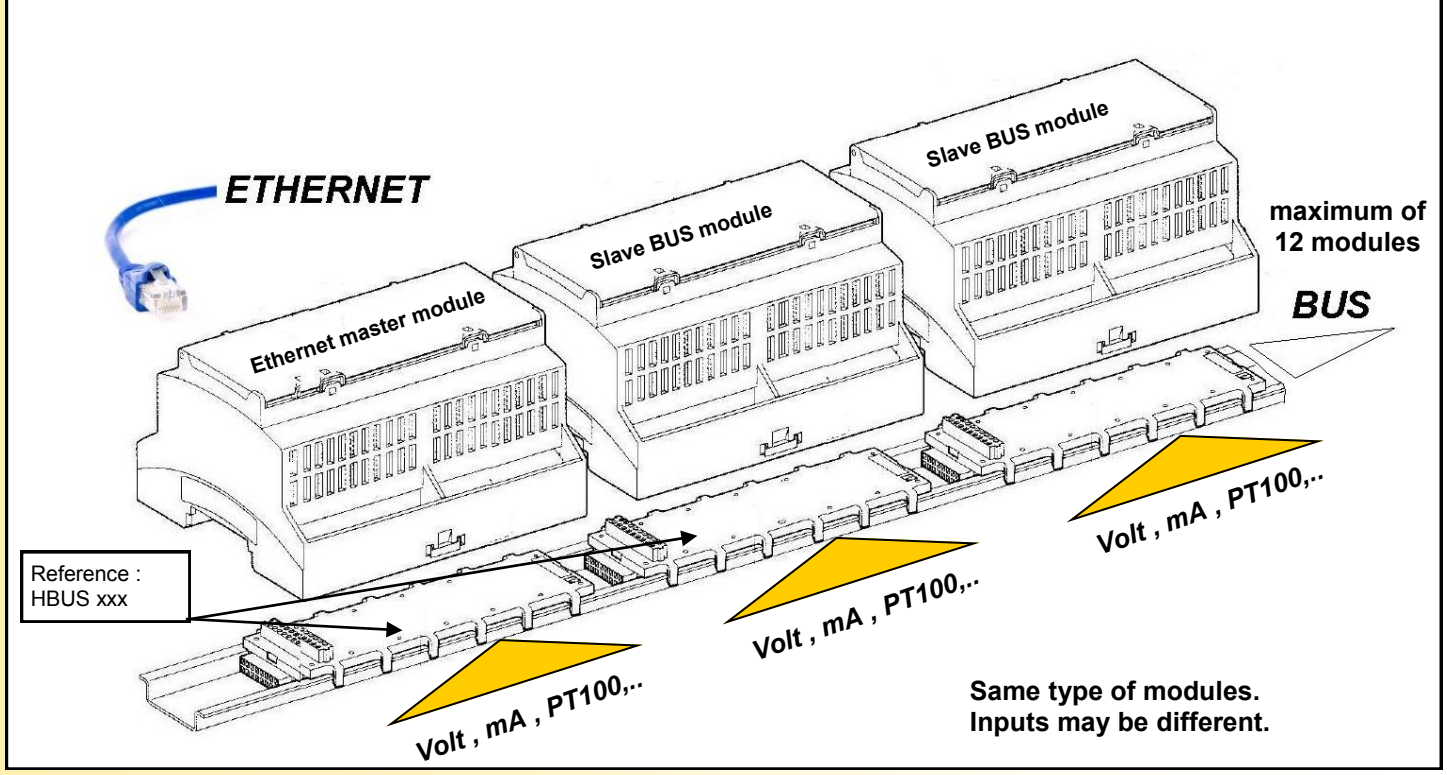

Heterogeneous bus : (different type of modules on bus) the network head-end (Ethernet, wifi) is independent .

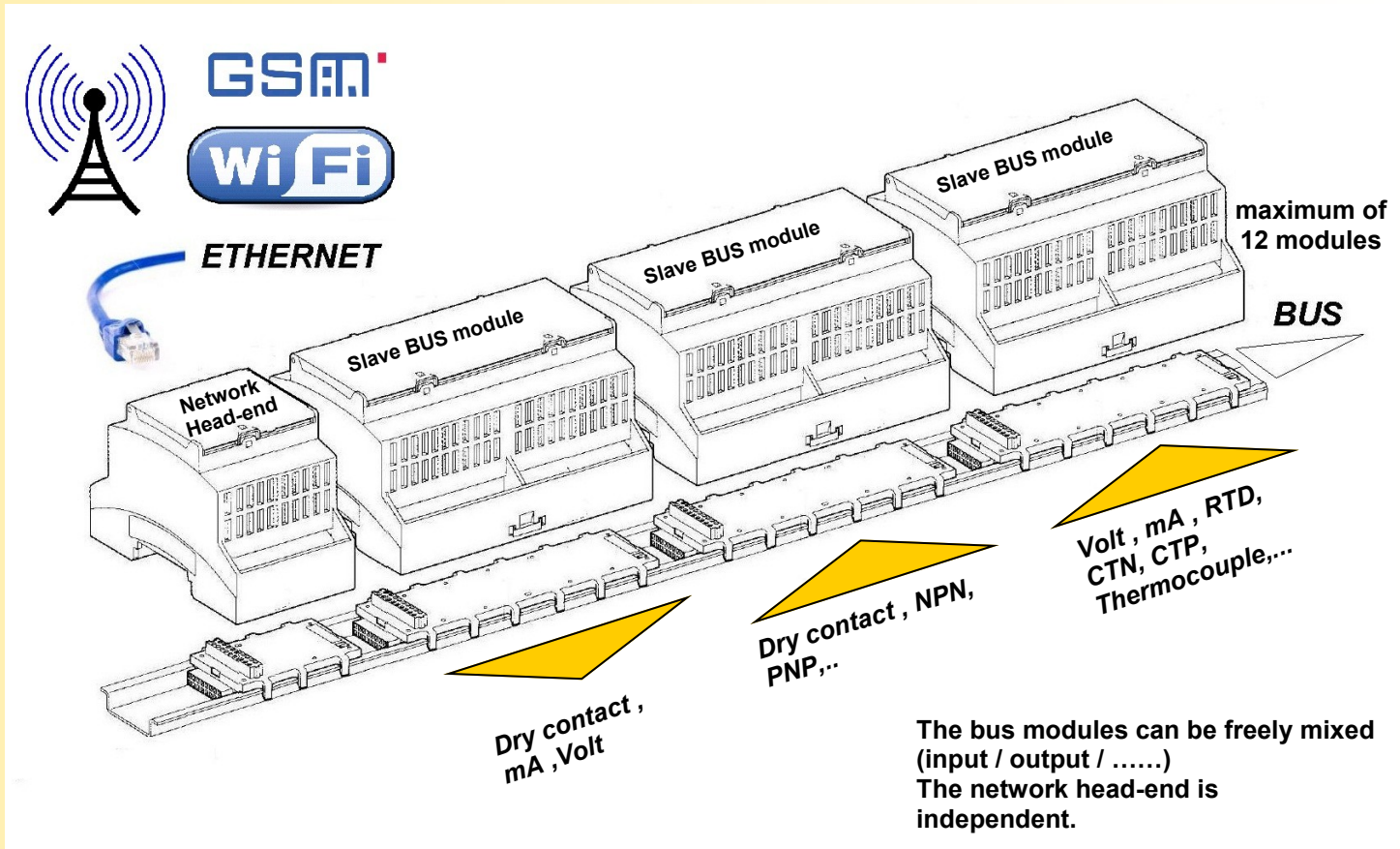

Description of network head-end (report to data sheet of each module for more details)
 Ethernet head-end : **TEH70**
 Wifi head-end : **TWi70**
 GSM head : **GSM71** establishes a bridge in modbus TCP through the gsm network (use of two GSM71)

The Bus100 system



The modular system Bus100 is made up of one master module (module with Ethernet socket) and slave modules (BUS module without Ethernet connection). All of modules can be reachable through the Ethernet link via the internal bus. Each module can be accessed within a specific address range. The master is always visible in the address range 0 to 999. Slave modules are visible in the address range equal to : **1000 x BUS address**. The address on the bus parameter is configurable by the front face in each module. This parameter should be unique for each slave module on the bus. Like explain below, the address bus selection is equivalent to moving the address range in the device.

Example of Bus configuration:

For each module a range of 1000 modbus registers address is allocated in function of its bus address. The higher address on each module are reserved for system functioning and are not accessible to users (grey zone).

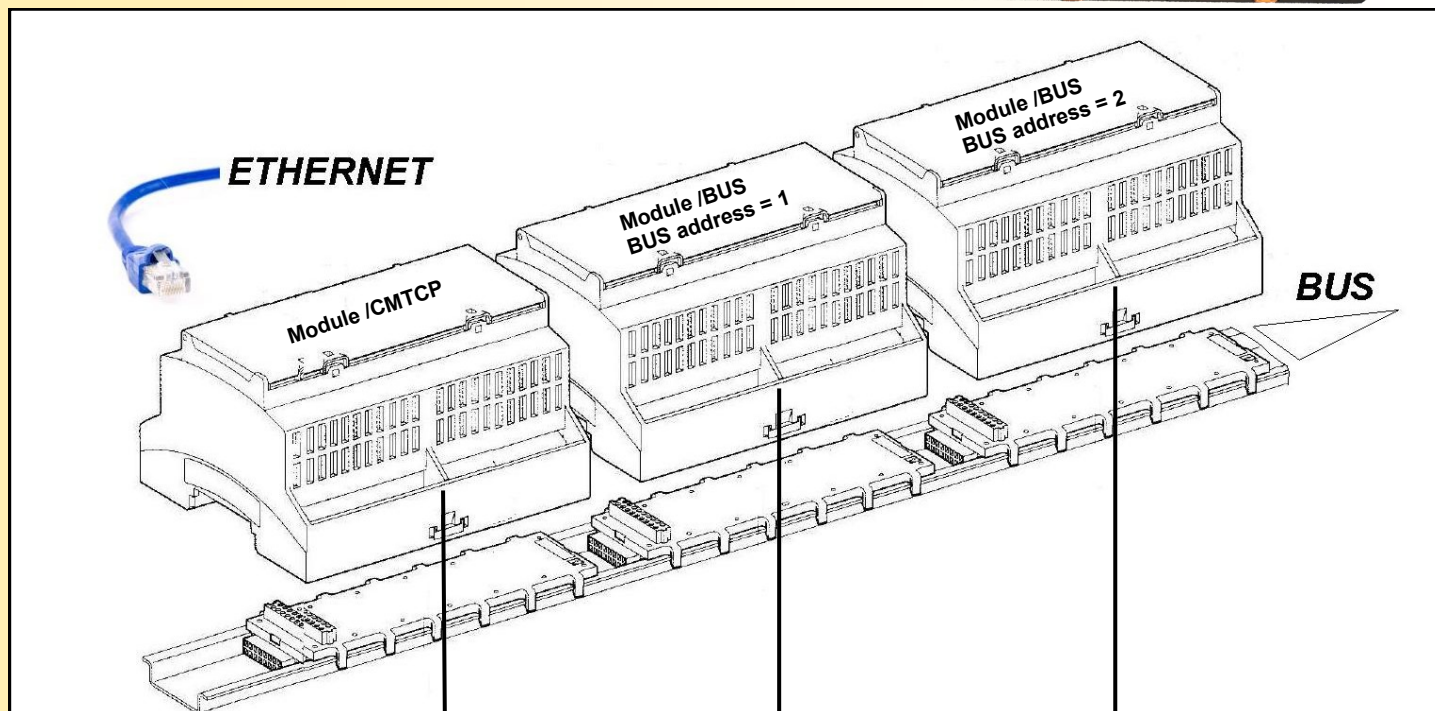

Possible address range		Possible address range		Possible address range	
from	0000	from	1000	from	2000
	Data registers range (measure, status,...)		Data registers range (measure, status,...)		Data registers range (measure, status,...)
	<i>(The length of this range depend on device type)</i>		<i>(The length of this range depend on device type)</i>		<i>(The length of this range depend on device type)</i>

	Range not accessible to user		Range not accessible to user		Range not accessible to user
	registers reserved for configuration		registers reserved for configuration		registers reserved for configuration

to	0999 Address reserved for device identification code	to	0999 Address reserved for device identification code	to	0999 Address reserved for device identification code

Input / Output module available :
Analog inputs



• **CML100 : 8 or 16 not isolated analog inputs**

[CML100 Datasheet \(pdf\)](#)

RTD inputs (PT100 , PT1000)

Thermocouple inputs (J ,K ,S , T)

Thermistor inputs CTN , CTP

0..1.....5.....10Volts ; 0...4.....20mA

Strain gauge

Current : 0...5A.....100Aac with current split-core transformer

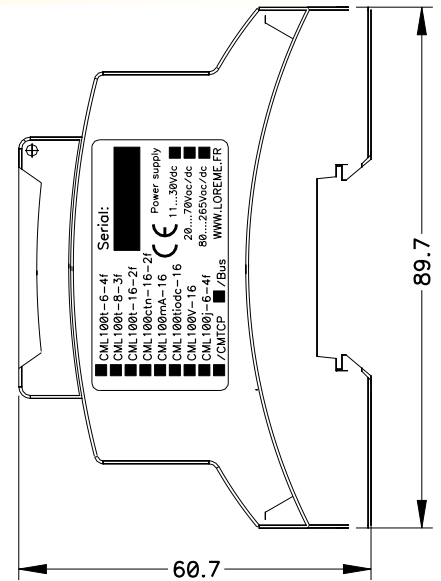
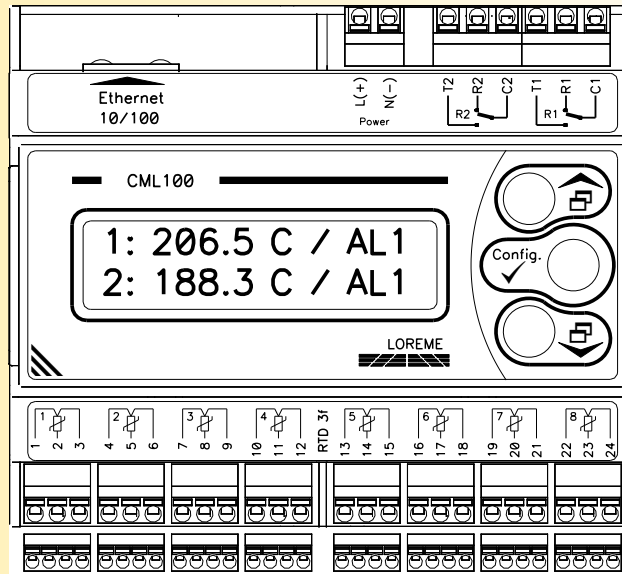

• **CML165 : 12 isolated analog inputs**

[CML165 Datasheet \(pdf\)](#)

CML165T (mV, thermocouple, PT100 3 wires)

CML165P (4...20 mA and 0...10V)

- each input may be individually configured.

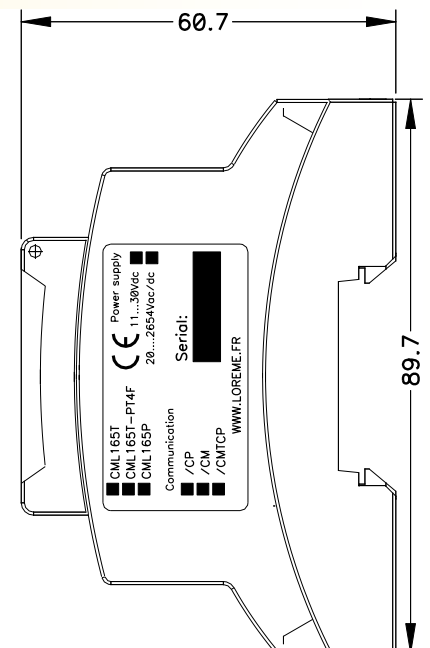
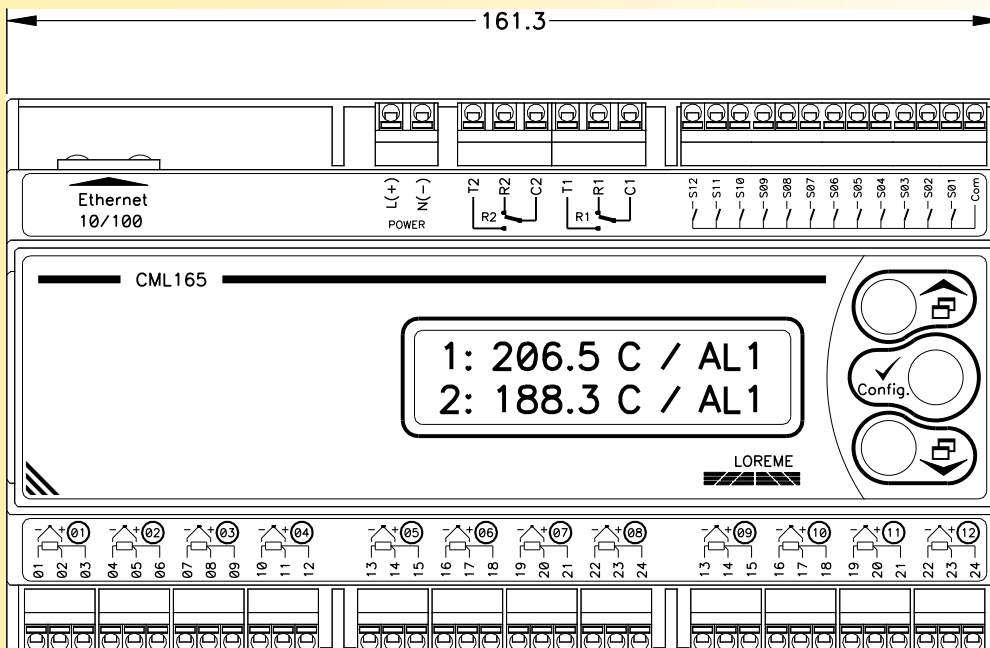

Input / Output module available :
Digital inputs



• **ELL100 : 16 digital inputs:**

[ELL100 Datasheet \(pdf\)](#)

Functions : status registers,
 32bits counters,
 "ON" and "OFF" elapsed time counters,
 inter pulse duration (power or flow rate)
 frequency up to 6 Hz

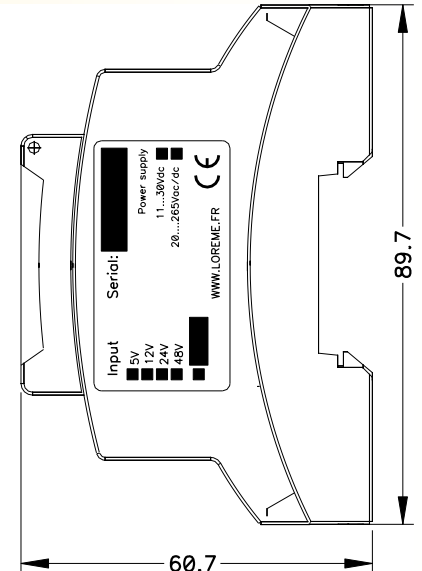
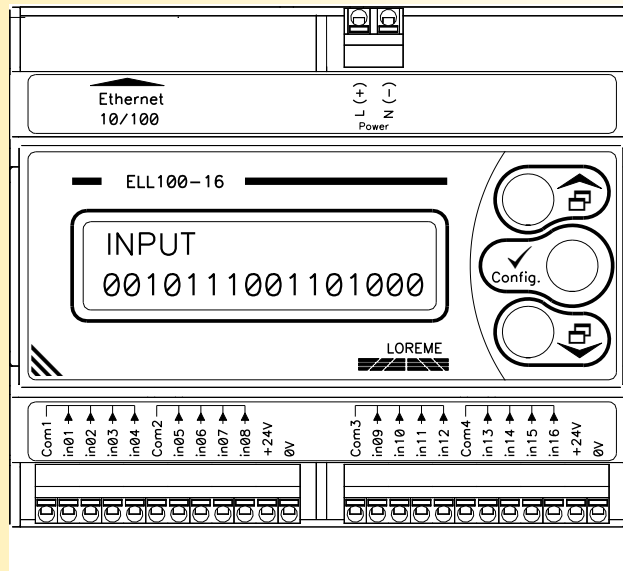

• **ELL165 : 24 digital inputs:**

[ELL165 Datasheet \(pdf\)](#)

Functions : status registers,
 32bits counters,
 "ON" and "OFF" elapsed time counters,
 inter pulse duration (power or flow rate)
 frequency up to 6 Hz

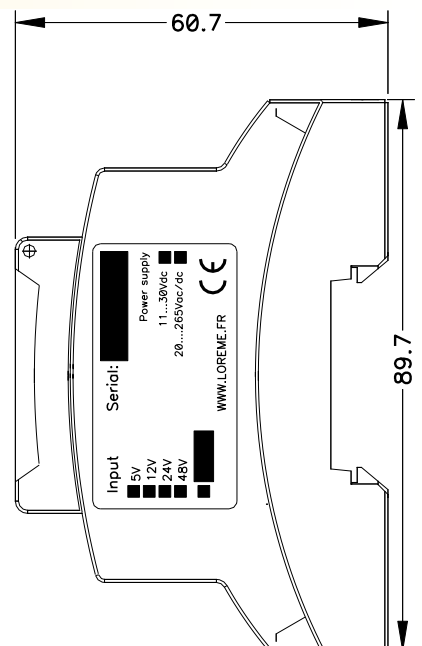
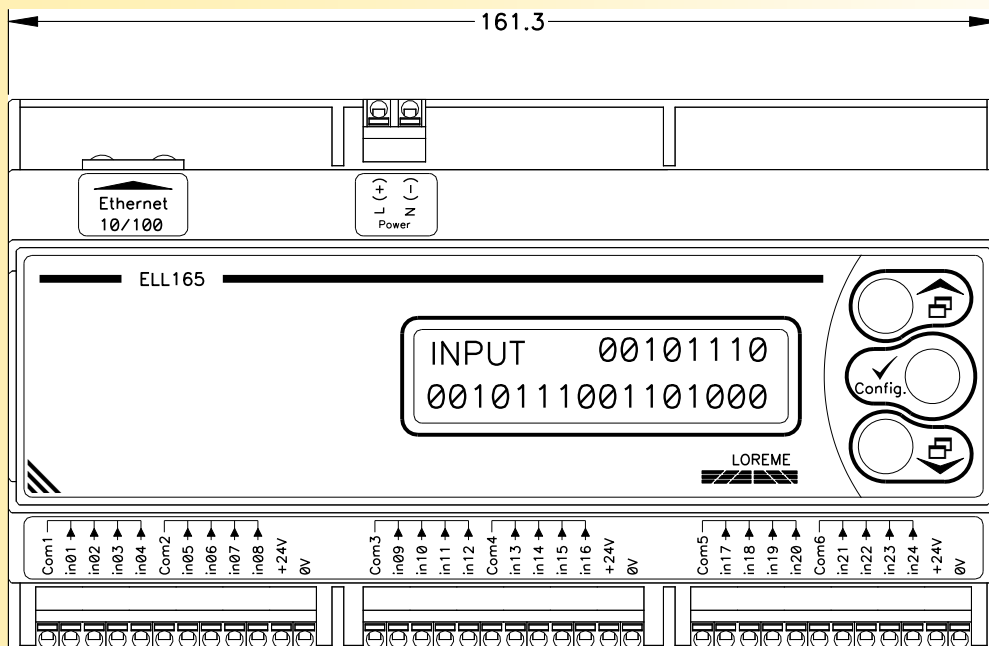

Input / Output module available :
Relay outputs



- **SRL100 : 8 relay outputs:**
 Changeover contact
 switching capacity 10Vdc / 2 mA to 250Vac / 2A
 Time-out delay and security value programmable

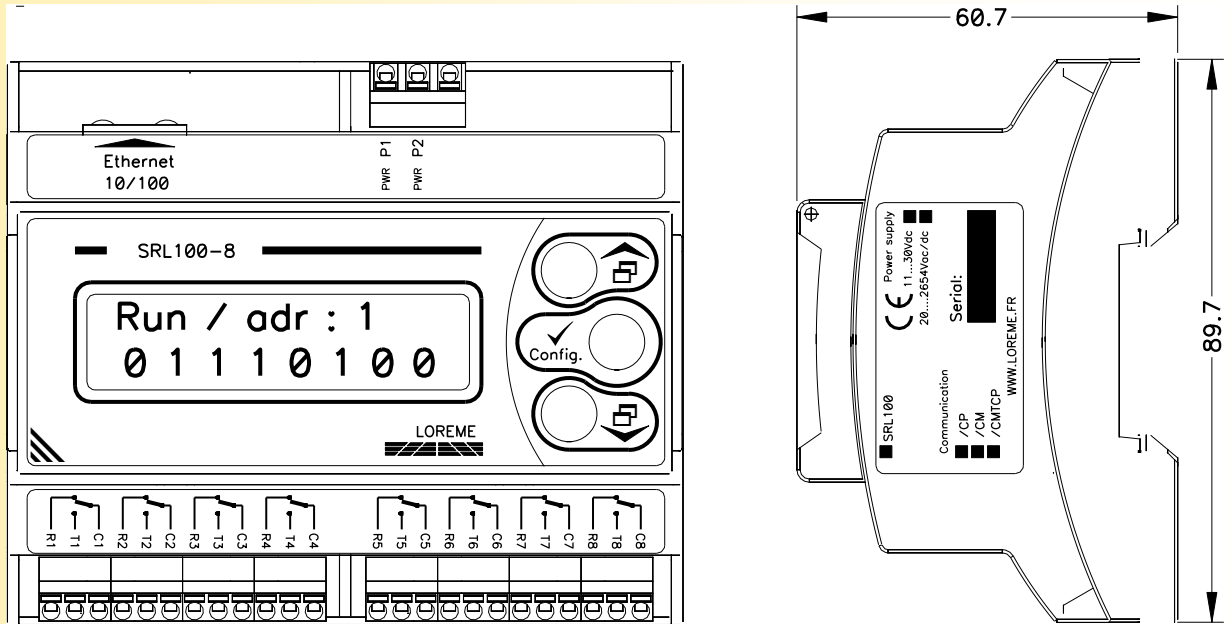

- **SRL165 : 12 relay outputs:**
 Changeover contact
 switching capacity 10Vdc / 2 mA to 250Vac / 2A
 Time-out delay and security value programmable

[SRL165 Datasheet \(pdf\)](#)

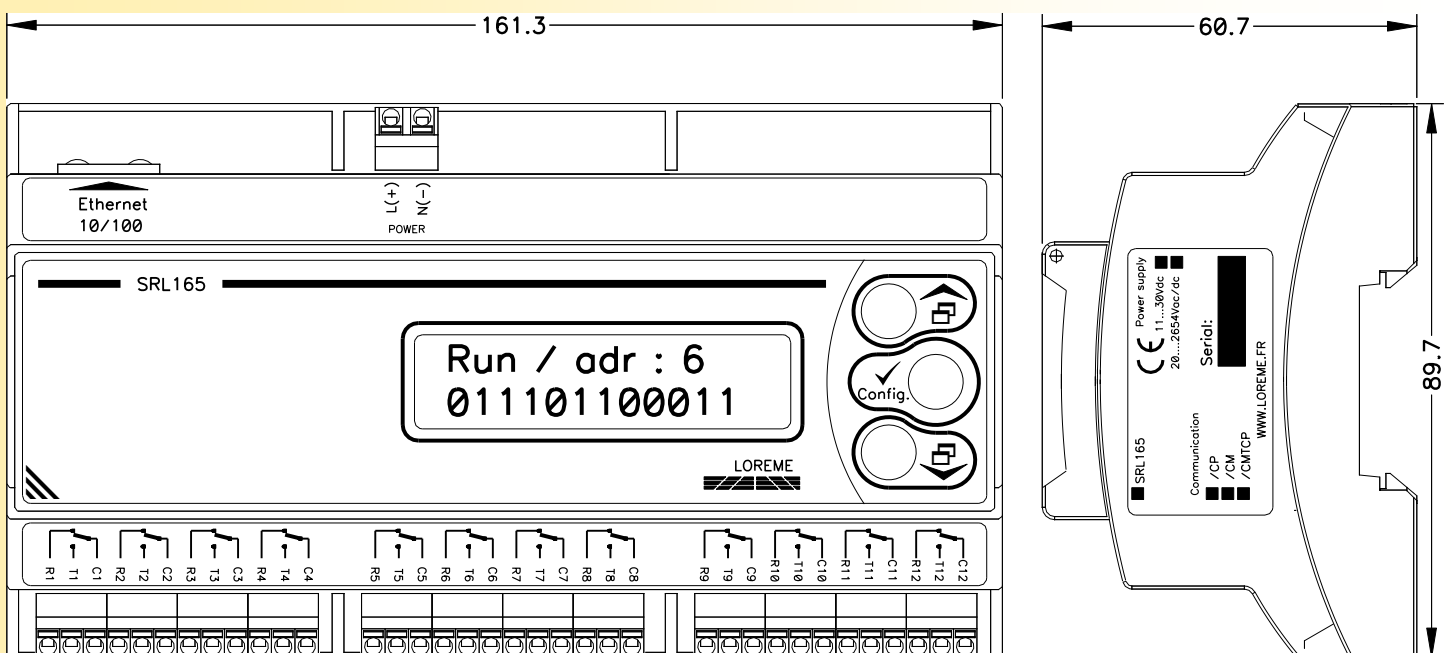

Input / Output module available :
Analog output - relay output - specific output



• **SRAL165 : 8 modular outputs (analog, Digital, specific), defined at order**

[SRAL165 Datasheet \(pdf\)](#)

Internal output slots:

- Isolated analog unipolar : 0...4...20mA and 0.....10V
- Isolated analog bipolar: +/- 20mA and +/- 10V
- standard changeover relay, switching capacity 10Vdc / 2 mA to 250Vac / 2A
- changeover power relay, switching power 250Vac / 6A
- static relay 60Vac-dc / 500mA or 400Vac-dc / 100mA
- or specific output on request (PWM , frequency, monostable ,.....)

Time-out delay and security value programmable (analog output and relay)

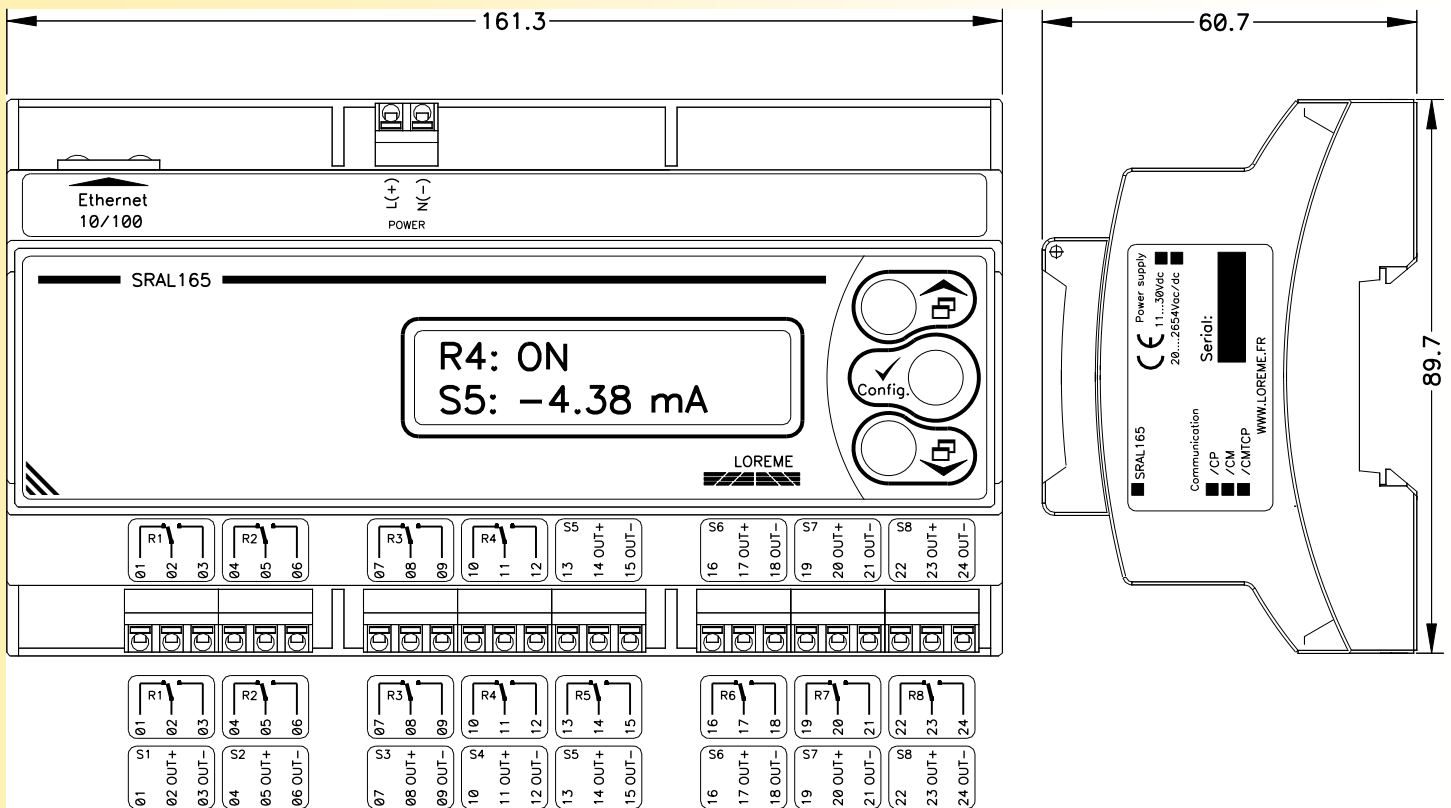

Input / Output module available :
Voltmeter, ammeter, wattmeter, energy meter ,....



- **CPL105 power converter and energy meter for electric networks**
- **Single phase or three phases networks**
Measure U, I, Cos, P, Q, W
- **3 relay output**
- **Can be used like 3 isolated single phase counters**
Option : CPL105-ISO (3 isolated voltage inputs)

[CPL105 Datasheet \(pdf\)](#)

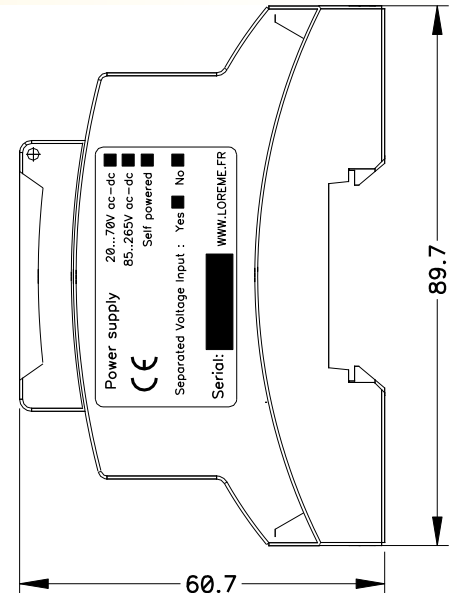
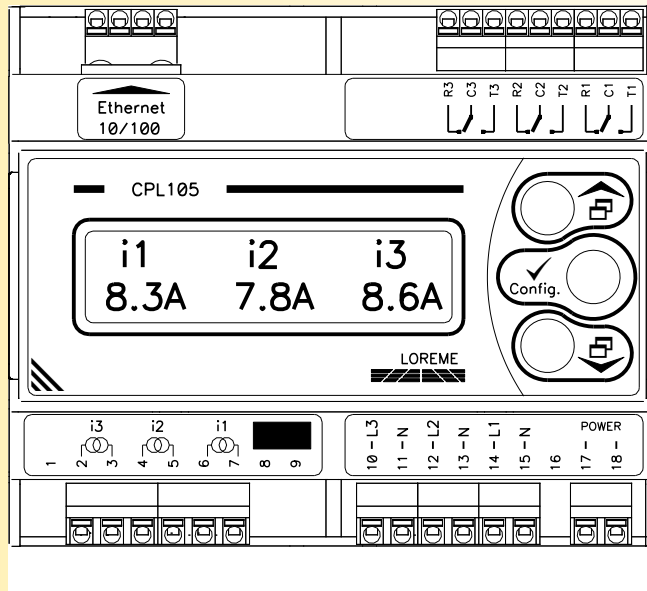

- **18 branch circuit energy counter**
Three phase or single phase, Measure of U, I, Cos, P, W
- **Current measurement from 1A to 500A**
with split-core current transformers
hole diameter : 12mm to 36mm

[CPL165 Datasheet \(pdf\)](#)

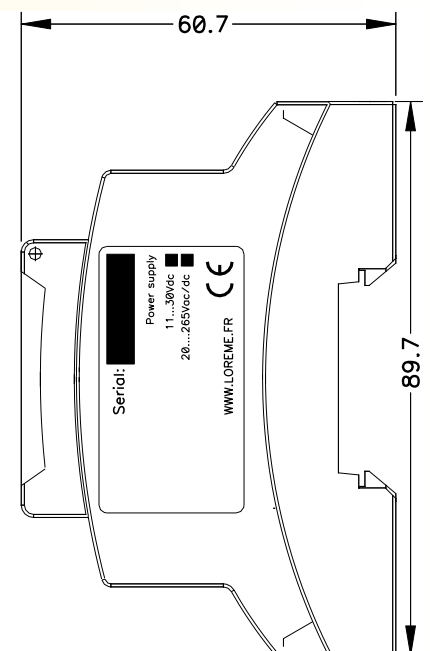
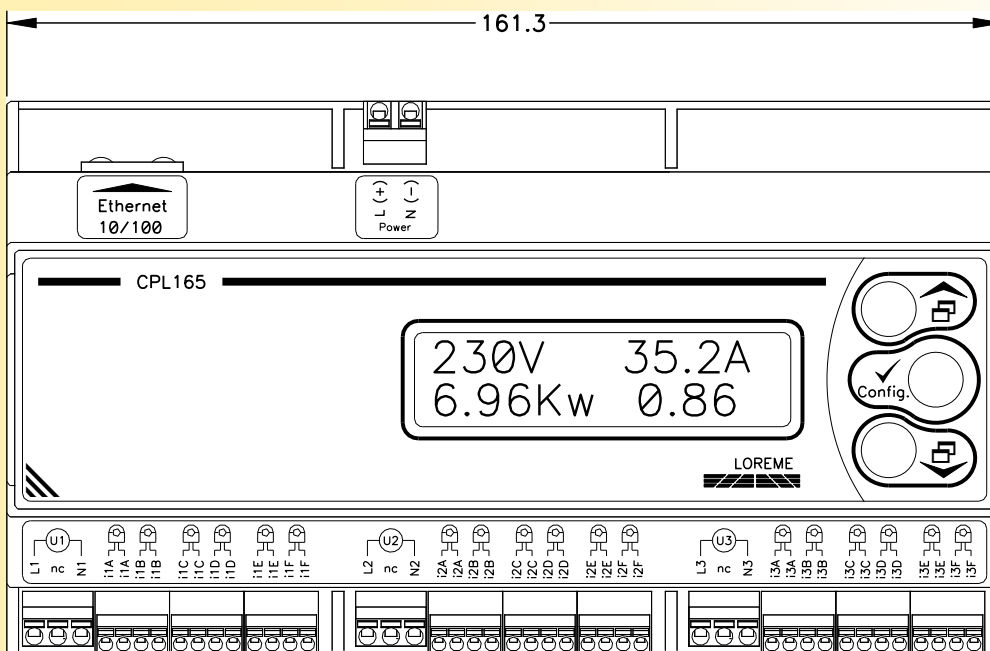

Ethernet communication concentrator for BUS100

*Automatic recognition of slave modules
mode "plug and play" or safety mode (Bus configuration saved)*

monitoring the status of overall bus with watchdog relay

Embedded Web server

*Web page for checking and control (slave module connected on bus
and corresponding address range)*



6 simultaneously Modbus TCP link

Buffering bus variables to improve response time

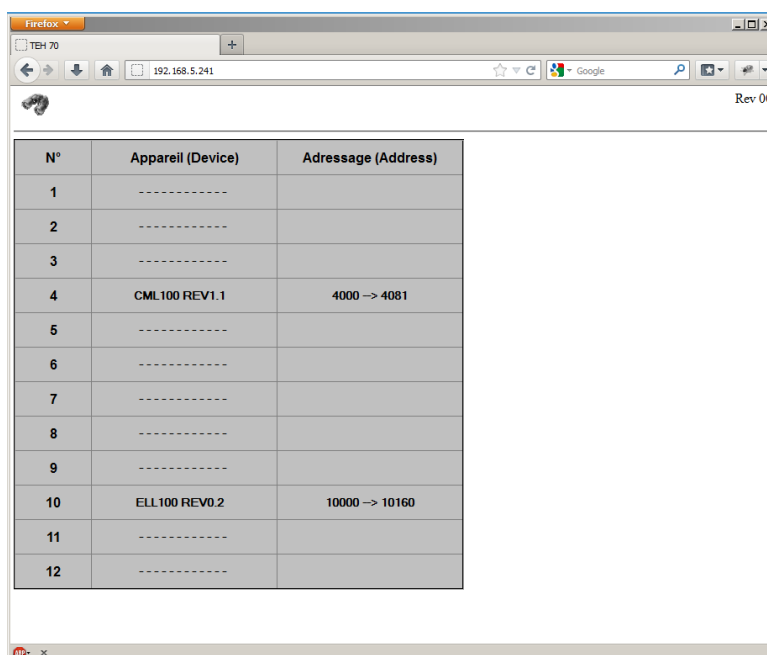
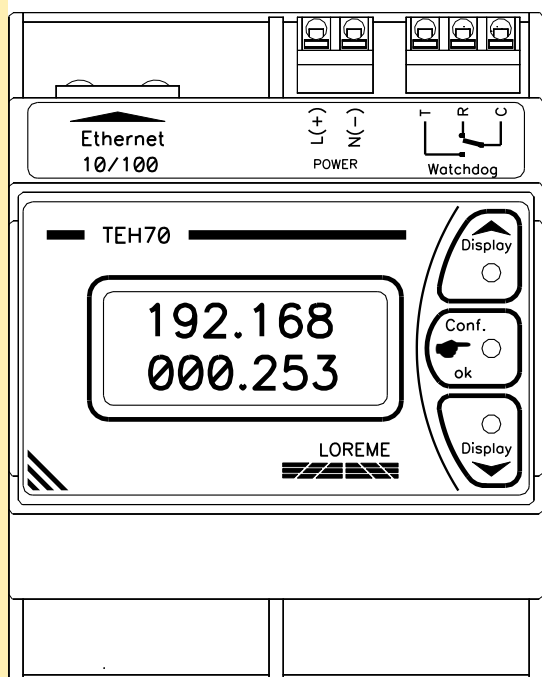
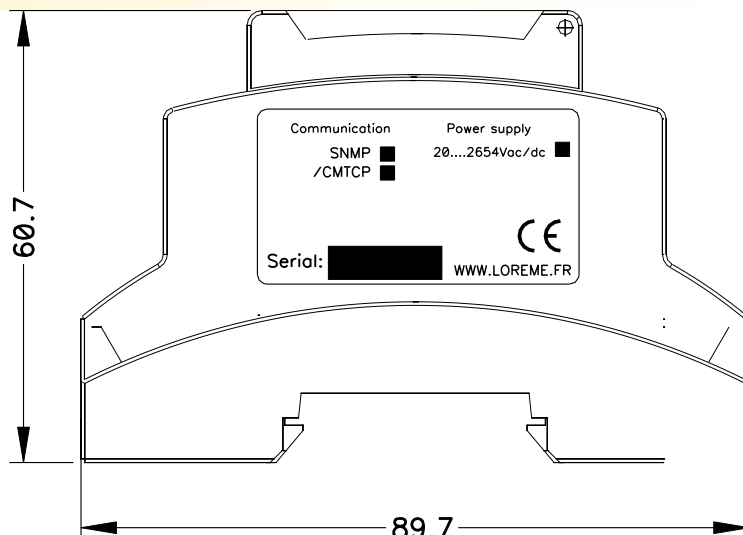
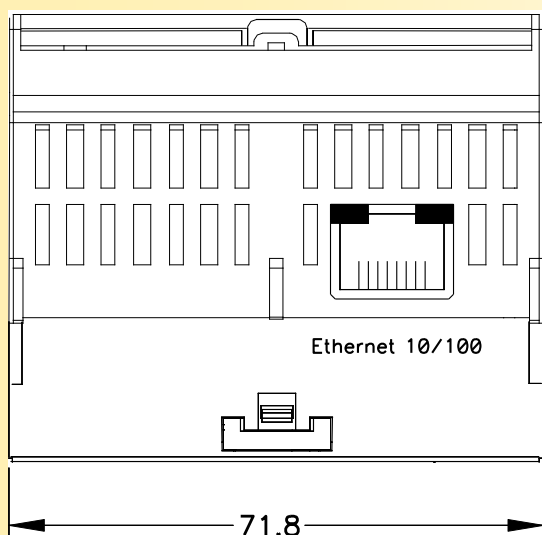

HBUS 70 DIN rail bus connector for 70mm width case (4 modules)

Technical data

General

colour black

Dimensions

Length 37,1 mm

Width 71,6 mm

Characteristics

Connection in accordance with standard CUL

Nominal voltage U_N 60 V

Nominal current I_N 2 A

Indicator1 CUL1

Flammability rating according to UL 94 V0

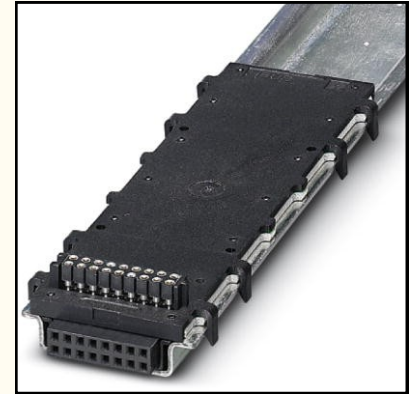
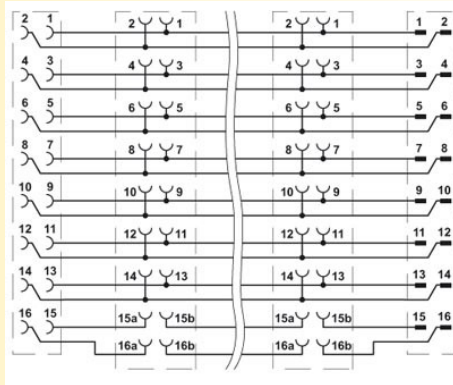

HBUS 107 DIN rail bus connector for 107mm width case (6 modules)

Technical data

General

colour black

Dimensions

Length 37,1 mm

Width 107 mm

Characteristics

Connection in accordance with standard CUL

Nominal voltage U_N 60 V

Nominal current I_N 2 A

Indicator1 CUL1

Flammability rating according to UL 94 V0

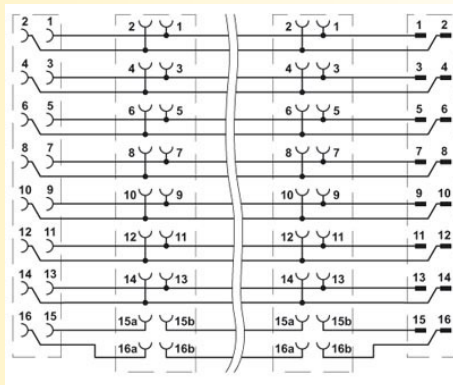

HBUS 161 DIN rail bus connector for 161mm width case (9 modules)

Technical data

General

colour black

Dimensions

Length 37,1 mm

Width 161,6 mm

Characteristics

Connection in accordance with standard CUL

Nominal voltage U_N 60 V

Nominal current I_N 2 A

Indicator1 CUL1

Flammability rating according to UL 94 V0

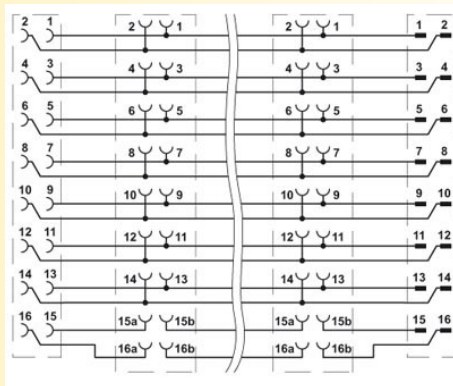

NAPPE BUS cable bridge for DIN rail connection of HBUS (Bus extension)

Technical data

section 0,25 mm²

Length :500 mm (max 1000 mm on request)

connectors female / male

only one cable per Bus

(the bridge cable should stay in cabinet and do not use it to link two cabinets)

Characteristics

Connection in accordance with standard CUL

Nominal voltage U_N 60 V

Nominal current I_N 2 A

Indicator1 CUL1

Flammability rating according to UL 94 V0

